

AXA25

Manual Generated: 27/12/2022 - 07:53

Table of Contents

AXA25	3
Introduction	4
What's included with the AXA25?	5
Front panel controls	6
Rear panel connections	8
Getting connected	10
Technical specifications	12
Troubleshooting	14
Frequently Asked Questions (FAQ)	15

AXA25

Last updated: August 2, 2022 02:04. Revision #7180

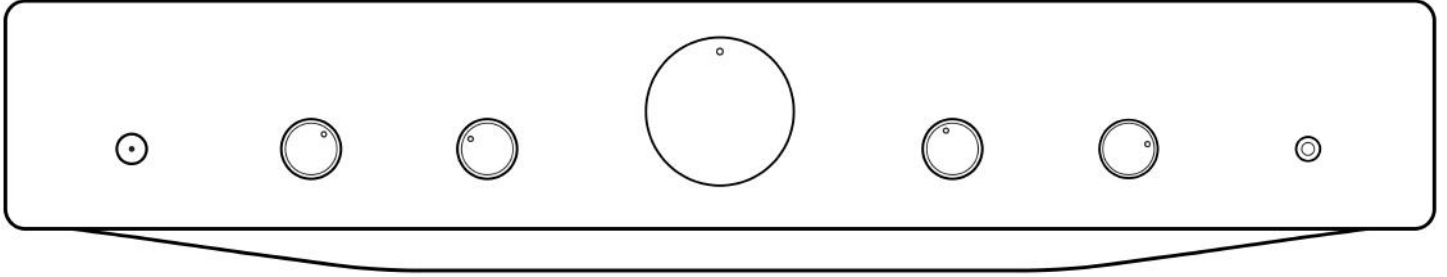

Users Manual

Introduction

Last updated: July 29, 2022 10:23. Revision #7181

This guide is designed to make installing and using this product as easy as possible. Information in this document has been carefully checked for accuracy at the time of printing; however, Cambridge Audio's policy is one of continuous improvement, therefore design and specifications are subject to change without prior notice.

This document contains proprietary information protected by copyright. All rights are reserved. No part of this manual may be reproduced by any mechanical, electronic or other means, in any form, without prior written permission of the manufacturer. All trademarks and registered trademarks are the property of their respective owners.

© Copyright Cambridge Audio Ltd

For upcoming news on future products, software updates and exclusive offers, make sure you register your product at <https://www.cambridgeaudio.com/register>

What's included with the AXA25?

Last updated: August 1, 2022 04:13. Revision #7182

Inside the box of your AXA25 you will receive:

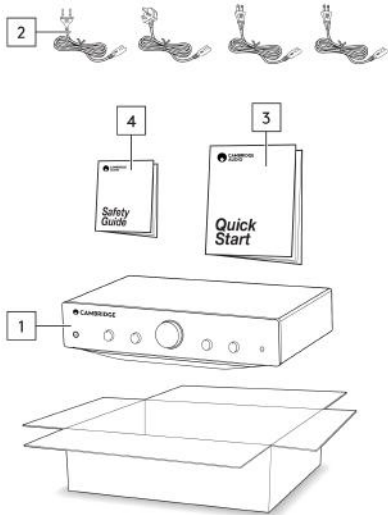

1. AXA25 integrated amplifier.
2. UK mains lead (depending on which country the AXA35 was purchased).
EU mains lead (depending on which country the AXA35 was purchased).
CU mains lead (depending on which country the AXA35 was purchased).
JP mains lead (depending on which country the AXA35 was purchased).
3. Quick start guide.
4. Safety guide.

Front panel controls

Last updated: July 29, 2022 10:23. Revision #7183

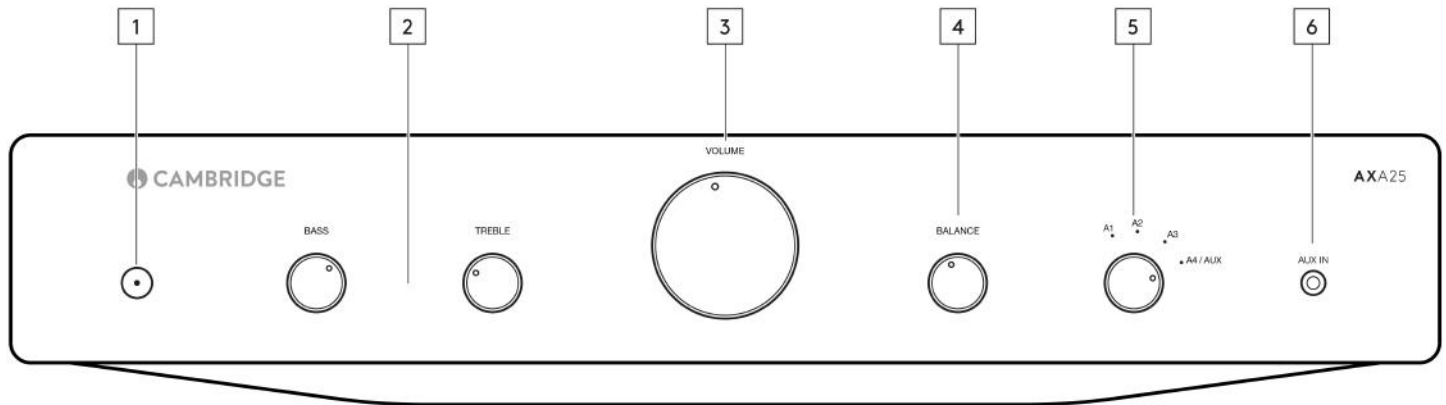

1. Power button - Switches the unit between Standby mode (indicated by dim LED) and On (indicated by bright LED). Standby mode is a low power mode where the power consumption is less than 0.5 Watts.

This product has APD (Auto Power Down) enabled as default. After inactivity of 20 minutes, the product will automatically switch to Standby.

Auto Power Down (APD)

You can enable and disable the unit's APD setting. This can be adjusted by pressing and holding the Power button until the LED flashes in sequence. The two options below show which option is selected.

Standby flashes 5 times - APD disabled

Standby flashes 10 times - APD enabled

Note: Make sure the unit is On, before making changes to the APD function.

2. Bass and treble controls - These controls allow subtle adjustments to the tonal balance of the sound. In the central position (12 O'clock) these controls have no effect.

These controls only modify the sound through your loudspeakers, and do not affect the signals sent through the Rec Out connections. If the musical recording is of poor quality or other factors are affecting the sound quality, it may be necessary to adjust these tone controls to compensate.

3. Volume control - Use to increase or decrease the audio output level of the unit.

Note: The volume control does not affect the level of the 'Rec Out' output as this has a fixed level.

4. Balance - This control allows you to adjust the relative output levels of the left and right channels. In the central position (12 O'clock) the output from each channel is equal.

This control only modifies the sound through your loudspeakers - it does not affect the signals sent through the Rec Out connections.

5. Source selector switch (A1, A2, A3, A4/AUX) - Select the appropriate input source component that you wish to listen to. The signal selected is also fed to the Rec Out sockets so that it may be recorded. The input should not be changed whilst recording.

Note: There will be no sound from the amp if the correct input source isn't selected.

6. Aux in - This source input allows you to connect a portable audio device, such as a smart phone, directly into the front of the unit using a 3.5mm stereo Aux lead.

Once plugged in, this input is automatically selected, although other inputs apart from A4 can still be selected once a stereo-jack is plugged in. The A4/AUX option on the front of the unit will select this input whilst a stereo-jack is plugged in.

Note: Plugging a source into the front panel Aux input overrides the A4 input. Simply remove the jack from the front panel to automatically re-

enable the A4 input.

Rear panel connections

Last updated: July 29, 2022 10:23. Revision #7184

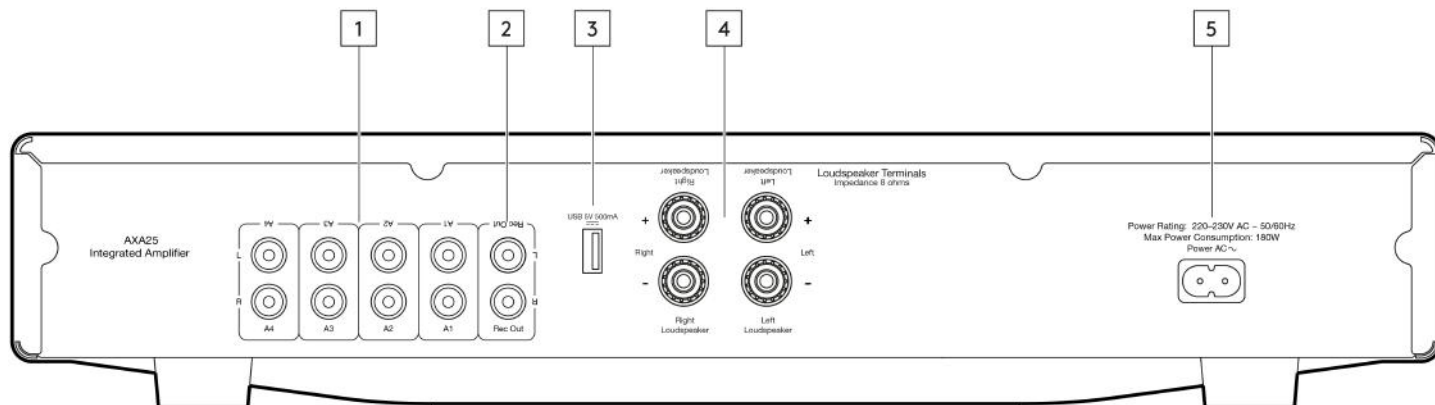

1. Audio inputs (A1-A4) - These inputs are suitable for any 'line level' source equipment such as the audio outputs of CD players, streaming devices such as a Chromecast Audio (RCA Phono to jack cable required) etc.

2. Rec out - Connect to the recording input of a CD recorder, tape deck or other compatible recording device etc.

This output provides a constant high level output that does not fluctuate with the volume, balance or tone controls of the main unit. For this reason, the AXA25 cannot be used as a Preamplifier only or with a subwoofer.

3. USB power 5V 500mA - This USB connection is designed to charge a device, such as a smartphone. The charging device needs to require 5V DC to be able to be charged.

Note: This is **not** an input so will not allow you to play audio directly to the unit.

Note: Do **not** use this port for charging a device and using it as a source at the same time, as this will create a ground loop that will cause interference during playback.

4. Loudspeaker terminals - **Note:** When using a banana plug, make sure the speaker terminals are completely tightened before inserting the plug.

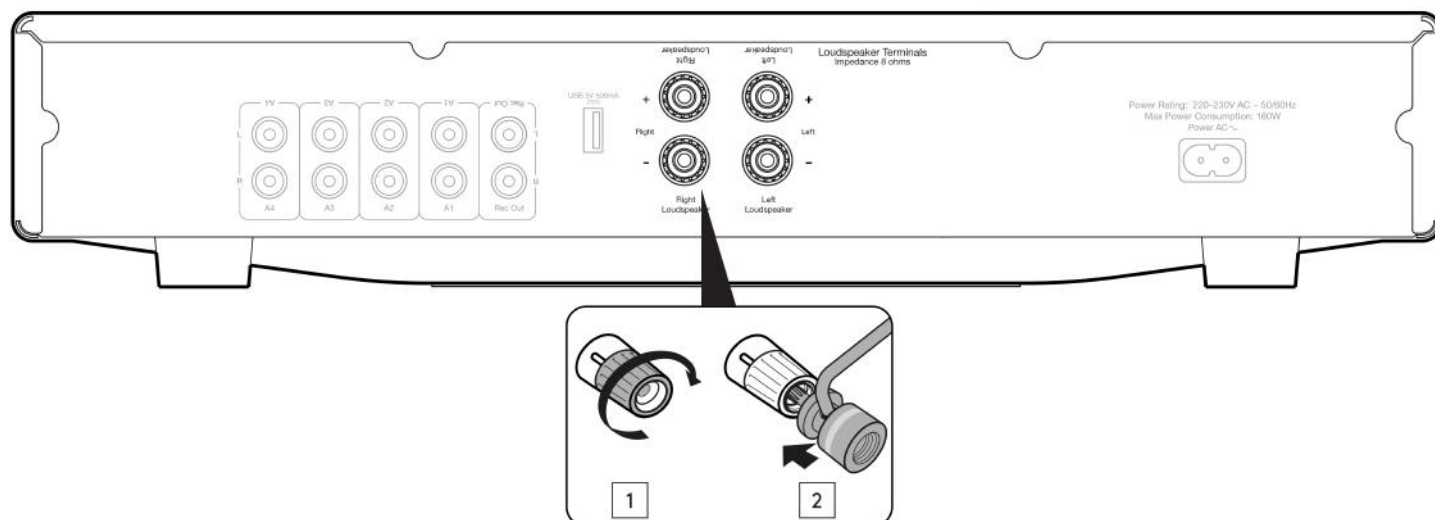

Connect the wires from your left channel loudspeaker to the Left positive and negative terminals and the wires from the right channel loudspeaker to the Right positive and negative terminals.

In each case, the red terminal is the positive output and the black terminal is the negative output.

Care should be taken to ensure no stray strands of wire are accidentally connecting speaker outputs together as this may cause damage to the unit.

Please ensure that the loudspeaker terminals have been tightened adequately to provide a good electrical connection. It is possible for the sound quality to be affected if the screw terminals are loose.

5, AC power socket - Once all connections are complete, plug the AC power cable into an appropriate mains socket and turn the unit on.

Please only use the power lead supplied with the unit.

Getting connected

Last updated: July 29, 2022 10:23. Revision #7185

Loudspeakers.

Check the impedance of your speakers. You can use speakers with an impedance of 8 Ohms.

The red coloured speaker terminals are positive (+) and the black speaker terminals are negative (-). Make sure correct polarity is maintained at each speaker connector or the sound can become weak and phased with little bass.

Using bare wire connections.

Prepare the speaker cords for connection by stripping off approximately 10mm (3/8") or less of the outer insulation. More than 10mm could cause a short circuit. Twist the wires tightly together so there are no loose ends. Unscrew the speaker terminal, insert the speaker cable, tighten the terminal and secure the cable.

Note: All connections are made using standard loudspeaker cable.



Using banana plugs.

We recommend using Banana plugs with our units to establish a secure connection and ensure there are no loose strands of wire that may cause unwanted noise or interference.

Once you have stripped the outer insulation of the cable and twisted the wires as indicated below, securely connect these to your banana plugs, remove the dust cap from the end of the speaker terminal and push the plug in as far as possible without applying excessive force.

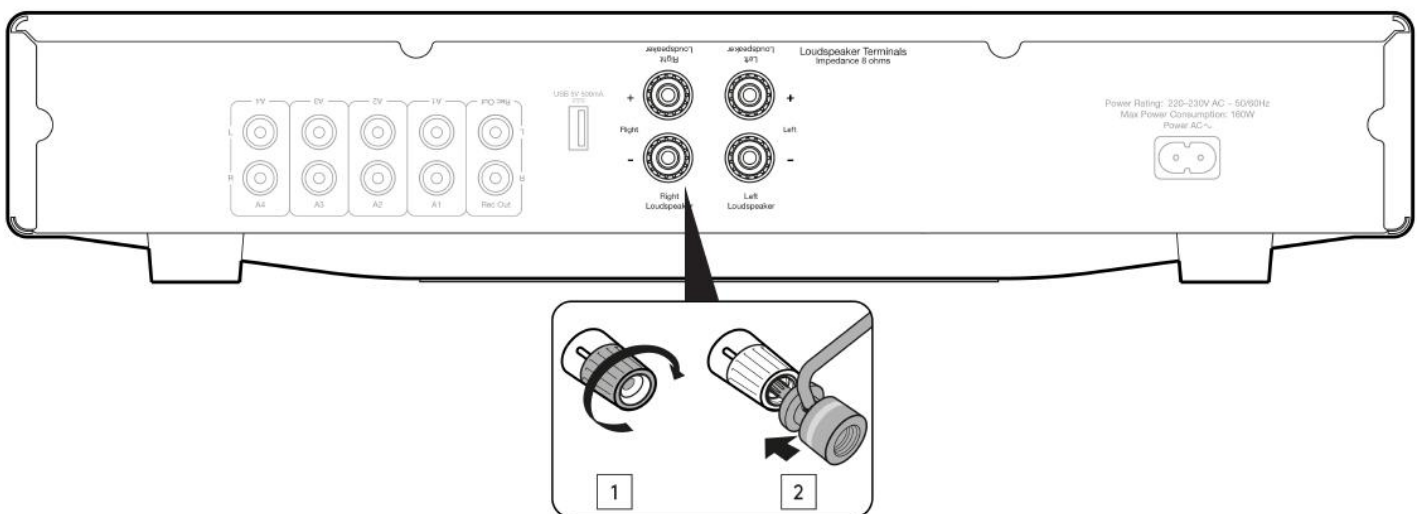

Note: When using a banana plug, make sure the speaker terminals are completely tightened before inserting the plug.

Basic connection.

The diagram below shows the basic connection of the AXA25 to a CD player and a pair of loudspeakers.

Any 'line level' source equipment can be connected to the audio inputs on the amplifier (A1 to A4).

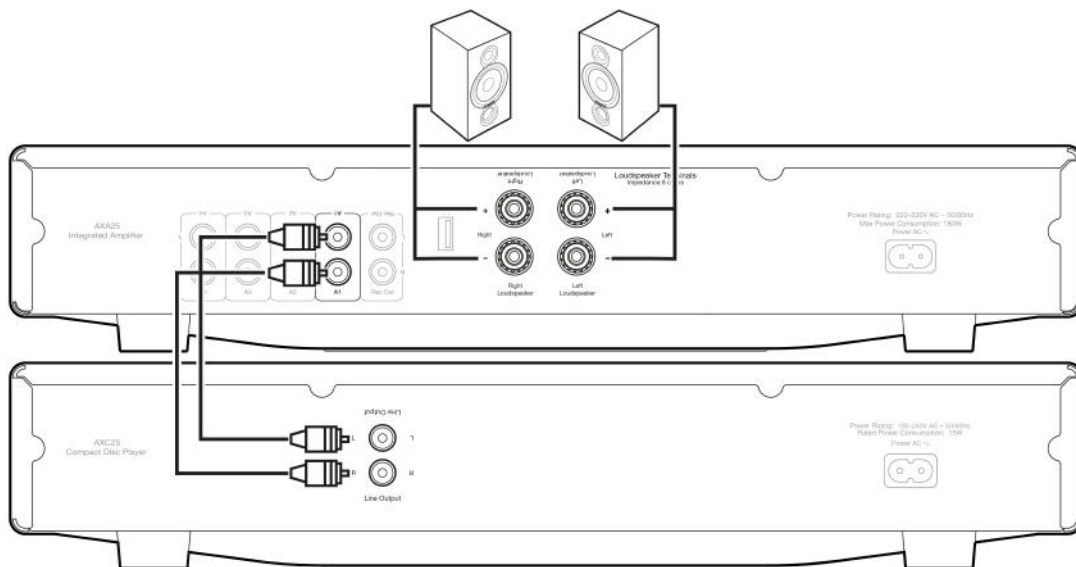

Technical specifications

Last updated: July 29, 2022 10:23. Revision #7186

Power output

25 Watts (into 8Ω)

THD (unweighted)

0.015% @ 1kHz, 80% of rated power <0.15% 20Hz - 20kHz, 80% of rated power <0.1% 20Hz - 20kHz @ 10W

Frequency response

(-3dB) 10Hz - 30kHz

S/N ratio

(ref 1W) >82dB (unweighted)

Input impedances

32k Ohms

Power Amp damping factor

>100

Max. power consumption

180W

Bass/Treble controls

Shelving, ultimate boost/cut +/- 5.5dB @ 20Hz and 20kHz

Standby power consumption

<0.5W

Inputs

4x RCA, 1 x 3.5mm Aux input (front panel)

Outputs

Speakers, Rec Out, USB 5V power

Dimensions (HxWxD)

83 x 430 x 340mm (3.3 x 16.9 x 13.4")

Weight

5.1kg (11.2lbs)

Troubleshooting

Last updated: July 29, 2022 10:23. Revision #7187

THERE IS NO POWER

- Ensure the AC power cord is connected securely.
- Ensure the plug is fully inserted into the wall socket and is switched on.
- Check fuse in the mains plug or adaptor.
- Check the power button is on at the front of the unit.

THERE IS NO SOUND

- Check the correct input is selected on the front panel of the amplifier.
- Check that the speakers are connected correctly.

THE SOUND IS DISTORTED

- Check speaker connections.

THERE IS A HUM COMING FROM THE SPEAKER

- Ensure that all cable connections are secure.

THERE IS UNWANTED BACKGROUND NOISE AND INTERFERENCE

- Move the unit away from other electrical equipment that is likely to cause interference.
- Ensure that all cable connections are secure.
- Ensure that you are not charging a device via the USB port and using it as an audio source at the same time.

Frequently Asked Questions (FAQ)

Last updated: August 1, 2022 04:13. Revision #7188

How can I connect my turntable to the AXA25?

The AXA25 doesn't have a built-in Phono preamplifier (Phono Stage), so your turntable will require its own Phono Stage to be able to be connected directly to the audio inputs on the amplifier.

Any turntable without a built-in Phono Stage will need to be connected to an external Phono preamplifier to bring the overall level up to an audible level. This can then be connected to any of the AXA25's audio inputs.

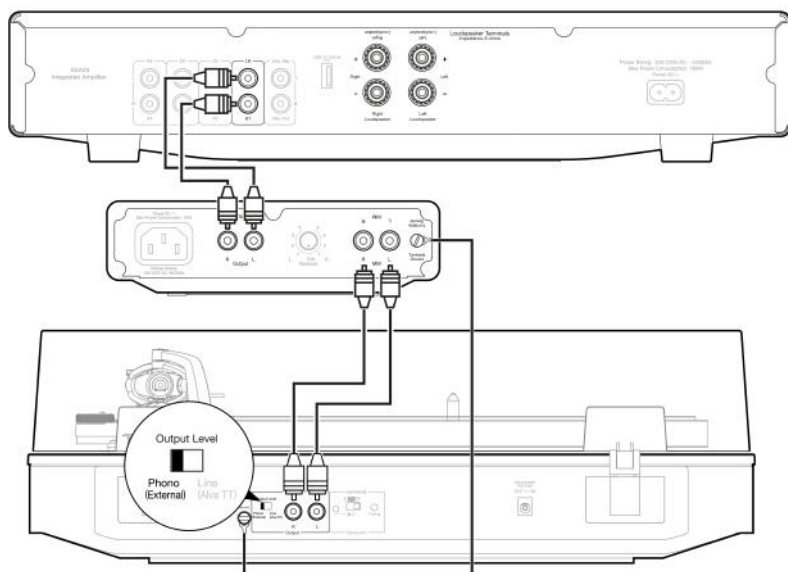

Why doesn't the AXA25's USB connection produce any sound?

The USB input on the rear of the AXA25 is not designed as an audio input. This is purely for charging devices and maintaining power to components such as a Streaming device.

Can I insert a Bluetooth adaptor into the AXA25's USB port to enable Bluetooth functionality?

No. The USB port on the rear of the AXA25 is only designed for charging a device, such as a smartphone. It is, therefore, not possible to insert a Bluetooth adaptor into this port to enable Bluetooth functionality with the AXA25.

Can I use 4 or 6 Ohm speakers with the AXA25?

The AXA25 is only rated to be used with 8 Ohm speakers and we would not recommend using it with 4 or 6 Ohm speakers. Using the AXA25 with 4 or 6 Ohm speakers could result in the amplifier overheating, which in the long run could damage the unit.