

TAGA[®]

CHARMONY

To Achieve Glorious Acoustics

HTA-700B v.3-USB / HTA-700B v.3

HIGH-FIDELITY HYBRID INTEGRATED AMPLIFIER

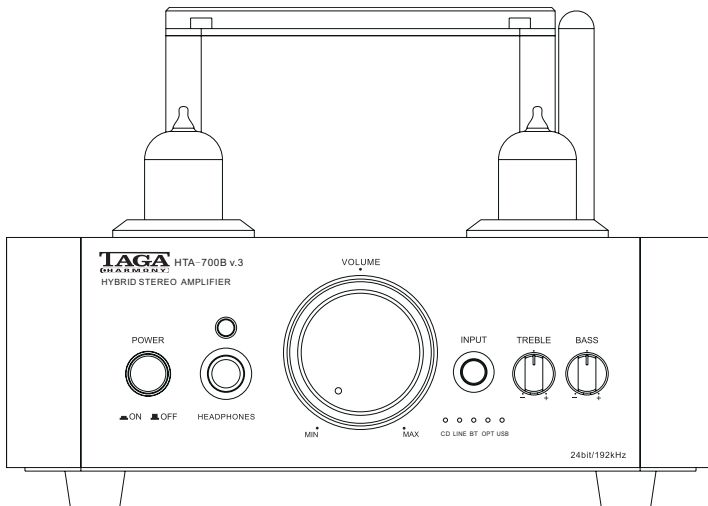

Instruction Manual

Introduction

Thank you for purchasing this TAGA Harmony amplifier.

HTA-700B v.3 is the latest edition of our highly-rewarded and extremely popular mid-size hybrid integrated amplifier.

It utilizes 2 x 12AU7 vacuum tubes in the preamp section serving as a buffer amplifier and a pair of TDA7296 transistors in the output.

The HTA-700B v.3 combines the best of both worlds - soft and analog-like sound character provided by tubes and adding to that high dynamics and power of transistors.

The 150W toroidal transformer provides large amounts of clean power, high voltage stability and very low AC ripple current. This reflects in higher dynamics and extra pure energy and greater abilities to properly drive different range of speakers.

High grade capacitors (2 x 50V/3300uF) ensure stable playback improving music tone and sound field depth.

To provide the best clarity of sound the HTA-700B v.3 utilizes audiophile-grade Wima capacitors which used on the input to and output from the tubes as well as for the tone regulators.

Audiophile grade Japanese ALPS volume potentiometer provides minimal noises and channels crosstalk and has excellent operational feel and limits errors between the two channels.

Oversized aluminum heat sink system (independent heat sink for each channel) helps to disperse internal heat and allows for long term high power playback with limited distortions.

The high-end class, gold-plated speaker terminals offer almost lossless audio signal transmission to speakers.

Beside two analog sources you can connect a range of digital devices via USB (only HTA-700B v.3-USB model) or optical inputs and a built-in high-resolution 24bit / 192kHz DAC will always provide the best sound performance.

The HTA-700B v.3 is also an ideal companion for mobile devices – stream music from smartphones, tablets or computers compatible with Bluetooth®.

For those who prefer discrete listening we equipped the HTA-700B v.3 with a high-end headphone preamplifier.

A preamplifier output is dedicated for an optional external power amplifier or powered subwoofer and speakers.

The HTA-700B v.3 offers additional options for easy upgrading the sound quality:

- Removable IEC power cable gives you an option to upgrade your system with a premium audiophile power cable in any time;
- The tubes are installed in high-quality ceramic sockets and they can be very easily exchanged for new tubes of your choice.

The HTA-700B v.3 is a splendid mixture of analog tube sound, power, precision, purity and multidimensional soundstage imaging!

Cleaning

Do not use strong or abrasive cleaners. Use a damp, soft cloth for cleaning.

Specifications

Full technical specifications are available on the www.TagHarmony.com website.

Contents

Safety Instructions	4
Important Safety Instructions	5
Remote controller	6
Front and Rear Panel	7
Hooking up speaker cables	8
Hooking up the amplifier	9
Operation	11
USB Connection (only HTA-700B v.3-USB model)	12
Bluetooth ® Connection	14
Additional information	15
Specifications	16
Kit content	17

Safety Instructions

IMPORTANT

READ THIS SECTION CAREFULLY BEFORE PROCEEDING!



CAUTION

**RISK OF ELECTRIC SHOCK
DO NOT OPEN**



WARNING: TO REDUCE THE RISK OF FIRE OR ELECTRIC SHOCK, DO NOT EXPOSE THIS PRODUCT TO RAIN OR MOISTURE. DO NOT REMOVE CHASSIS (OR BACK). NO USER-SERVICEABLE PARTS INSIDE. REFER SERVICING TO QUALIFIED SERVICE PERSONNEL.



The triangle containing a lightning symbol is intended to alert the user to the presence of uninsulated dangerous voltages within the product's enclosure that may be of sufficient magnitude to constitute a risk of electric shock to persons.



An exclamation mark in a triangle is intended to alert the user to the presence of important operating and maintenance (servicing) instructions in the literature accompanying the appliance.

WARNING: TO REDUCE THE RISK OF FIRE OR ELECTRIC SHOCK, DO NOT EXPOSE THIS APPARATUS TO RAIN OR MOISTURE, AND OBJECTS FILLED WITH LIQUIDS, SUCH AS VASES, SHOULD NOT BE PLACED ON THIS APPARATUS.

CAUTION: TO PREVENT ELECTRIC SHOCK, MATCH WIDE BLADE OF PLUG TO WIDE SLOT, FULLY INSERT.

CAUTION: FOR CONTINUED PROTECTION AGAINST RISK OF FIRE, REPLACE THE FUSE ONLY WITH THE SAME AMPERAGE AND VOLTAGE TYPE. REFER REPLACEMENT TO QUALIFIED SERVICE PERSONNEL.

WARNING: UNIT MAY BECOME HOT. ALWAYS PROVIDE ADEQUATE VENTILATION TO ALLOW FOR COOLING. DO NOT PLACE NEAR A HEAT SOURCE, OR IN SPACES THAT CAN RESTRICT VENTILATION.

Important Safety Instructions

1. Read Instructions - All the safety and operating instructions should be read before the product is operated.
2. Retain Instructions - The safety and operating instructions should be retained for future reference.
3. Heed Warnings - All warnings on the product and in the operating instructions should be adhered to.
4. Follow Instructions - All operating and use instructions should be followed.
5. Cleaning - Unplug this product from the wall outlet before cleaning. Do not use liquid cleaners or aerosol cleaners. Use a damp, soft cloth for cleaning.
6. Water and Moisture - Do not use this product near water - for example, near a bath tub, wash bowl, kitchen sink or laundry tub; in a wet basement; or near a swimming pool; and the like.
7. Accessories - Do not place this product on an unstable cart, stand, tripod, bracket or table. The product may fall, causing serious injury to a child or adult, and serious damage to the product. Use only with a cart, stand, tripod, bracket or table recommended by the manufacturer, or sold with the product. Any mounting of the product should follow manufacturer's instructions and should use a mounting accessory recommended by the manufacturer.
8. Ventilation - Slots and openings in the cabinet are provided for ventilation and to ensure reliable operation of the product and to protect it from overheating, and these openings must not be blocked or covered. The openings should never be blocked by placing the product on a bed, sofa, rug, or other similar surface. This product should not be placed in a built-in installation such as a bookcase or rack unless proper ventilation is provided or the manufacturer's instructions have been adhered to.
9. Power Sources - This product should be operated only from the type of power source indicated on the marking label. If you are not sure of the type of power supply to your home, consult your product dealer or local power company. For products intended to operate from battery power, or other sources, refer to the operating instructions.
10. Grounding and Polarization - This product may be equipped with a polarized alternating-current line plug (a plug having one blade wider than the other). This plug will fit into the power outlet only one way. This is safety feature. If you are unable to insert the plug fully into the outlet, try reversing the plug. If the plug should still fail to fit, contact your electrician to replace your obsolete outlet. Do not defeat the safety purpose of the polarized plug.
11. Power-Cord Protection - Power supply cords should be routed so that they are not likely to be walked on or pinched by items placed upon or against them, paying particular attention to cords at plugs, convenience receptacles, and the point where they exit from the product.
12. Lightning - For added protection for this product during a lightning storm, or when it is left unattended and unused for long periods of time, unplug it from the wall outlet and disconnect the antenna or cable systems. This will prevent damage to the product due to lightning and power-line surges.
13. Overloading - Do not overload wall outlets, extensions cords, or integral convenience receptacles as this can result in a risk of fire or electric shock.
14. Object and Liquid Entry - Never push objects of any kind into this product through openings as they may touch dangerous voltage points or short-out parts that could result in a fire or electric shock. Do not expose this apparatus to dripping or splashing, and ensure that no objects filled with water, such as vases, are placed on the apparatus.
15. Servicing - Do not attempt to service this product yourself as opening or removing covers may expose you to dangerous voltage or other hazards. Refer all servicing to qualified service personnel.
16. Damage Requiring Service - Unplug this product from wall outlet and refer servicing to qualified personnel under the following conditions:
 - When power supply cord or plug is damaged;
 - If liquid has been spilled, or objects have fallen into product;
 - If the product does not operate normally by following the operating instructions. Adjust only those controls that are covered by the operating instructions as an improper adjustment of other controls may result in damage and will require extensive work by a qualified technician to restore the product to its normal operation;
 - If the product has been dropped or damaged in any way;
 - If the product exhibits a distinct change in performance - this indicates a need for service.
17. Replacement Parts - When replacement parts are required, be sure the technician has used replacement parts specified by the manufacturer or have the same characteristics as the original part. Unauthorized substitutions may result in fire, electric shock, or other hazards.
18. Safety Check - Upon completion of any service or repairs to this product, ask the service technician to perform safety checks to determine that the product is in proper operating condition.
19. Wall or Ceiling Mounting - The product should be mounted to a wall or ceiling only as recommended by the manufacturer.
20. Heat - The product should be situated away from heat sources such as radiators, heat registers, stoves, or other products (including amplifiers) that produce heat.
21. [Refers to products equipped with vacuum tubes] Tube Cage - For your safety and to protect the vacuum tubes this product may be equipped with the factory installed vacuum tube cage.

It is not recommended to remove the cage unless it is required to change the vacuum tubes.
When the cage is removed - do not touch the vacuum tubes - they may be hot and burn the skin!

Remote Controller

Battery Installation

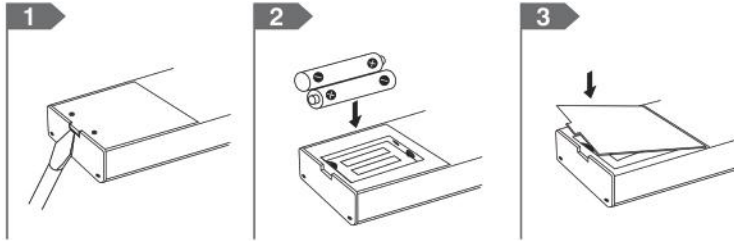

1. Open the cover of the battery compartment.
2. Insert two AAA batteries into the battery compartment. Carefully follow the polarity diagram inside the battery compartment (positive + and negative - symbols).
3. Replace the cover.

Note:

- Always use AAA batteries and do not use the rechargeable batteries.
- Do not mix new batteries with old batteries or different kinds of batteries.
- If the batteries run out, remove the old batteries and replace them with new ones within several minutes.
- If the batteries are placed incorrectly, they can cause explosion.
- Remove the batteries if the remote control is not used for a long period of time.
- Do not handle and store the batteries together with metallic tools.

Operating Range

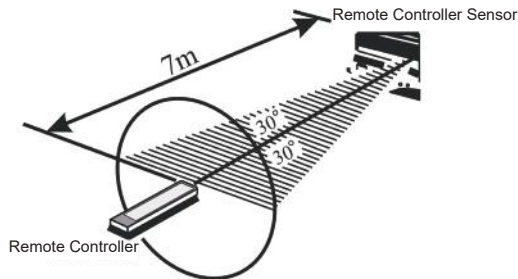

Use the remote controller by aiming it at the remote controller sensor. The remote controller can operate in the maximum range of 7 meters away from the amplifier and within 30 degrees from the axis of the controller sensor.

Note: Exposing the remote controller sensor to direct sunlight or strong light may cause faulty operation.

Remote Controller

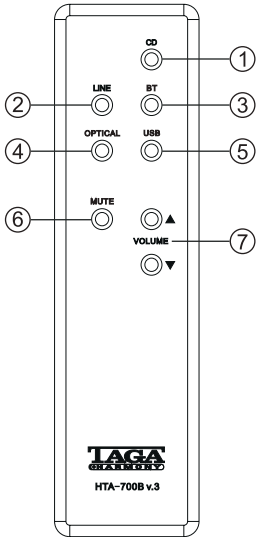

1. CD Input Selector Button
2. Line Input Selector Button
3. **Bluetooth**® Input Selector Button
4. Optical Input Selector Button
5. USB Input Selector Button (only HTA-700B v.3-USB model)
6. Mute Button
7. Volume Buttons (▼/▲)

Front and Rear Panel

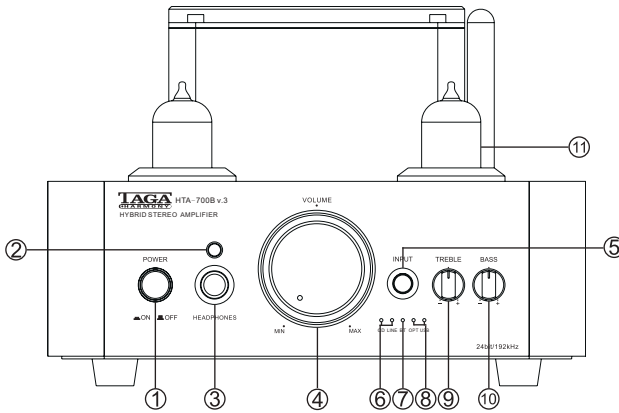

Front panel:

1. Power Button (ON and OFF)
2. Remote Controller Sensor
3. Headphone ¼" Jack Output
4. Volume Regulator
5. Input Selector Button
6. Analog CD / LINE Inputs Led Indicators (Red color)
7. **Bluetooth**® Input Led Indicator (Blue color)
8. Digital OPTICAL / USB* Inputs Led Indicators (Green color)
9. Treble Regulator
10. Bass Regulator
11. Vacuum Tubes

/HTA-700B v.3-USB model shown/

* (only HTA-700B v.3-USB model)

Front and Rear Panel

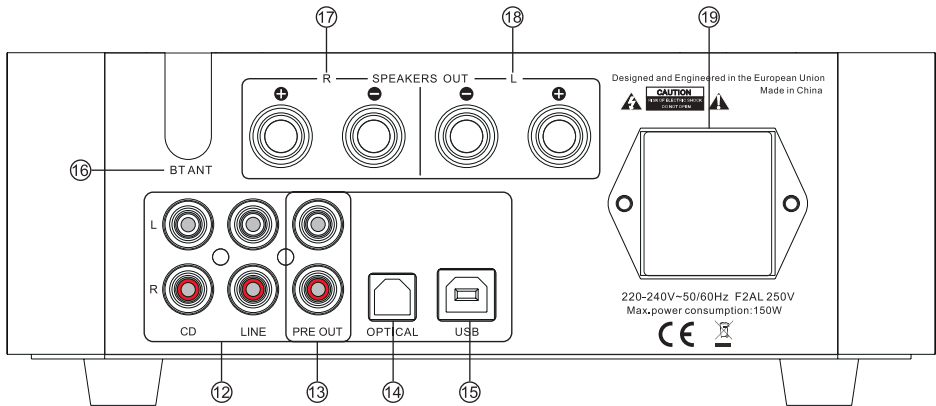

/HTA-700B v.3-USB model shown/

Rear Panel:

- 12. Analog Stereo RCA Inputs CD / LINE
- 13. Preamplifier Stereo RCA Output
- 14. Digital Optical Input
- 15. USB Input Port*
- 16. Bluetooth® Antenna and Antenna Socket
- 17. Speaker Right Channel Output (Speaker Connectors)
- 18. Speaker Left Channel Output (Speaker Connectors)
- 19. Power Cable Input and Fuse Box

Note! A blown fuse should be only exchanged for exactly the same type as indicated on the rear amplifier panel. The Power Cable should be disconnected!

* (only HTA-700B v.3-USB model)

Hooking Up Speaker Cables

The Speaker Connectors can accommodate up to 10AWG speaker cables as well as most of popular plugs (banana etc.). A 10AWG cable is recommended for longer connections (longer than 20 meters / 66 feet). For shorter lengths you can use 12/14 or 18 AWG cables.

It is recommended to leave about 150 cm (5 feet) of extra cable at the amplifier end to facilitate positioning and installation of the amplifier.

Do not use staples, nails or other metal objects to secure the cables. You will get the best sound quality and least amount of hum by keeping the cables away from other electrical wires and cables.

Pay attention to connecting the polarity of the amplifier correctly with the speakers in each speaker group (speakers should be connected RED + with RED + amplifier connector, BLACK – with BLACK – amplifier connector).

Before connecting make sure that your amplifier is switched off.

Please refer to your speaker instruction manual for more information.

Hooking up the Amplifier

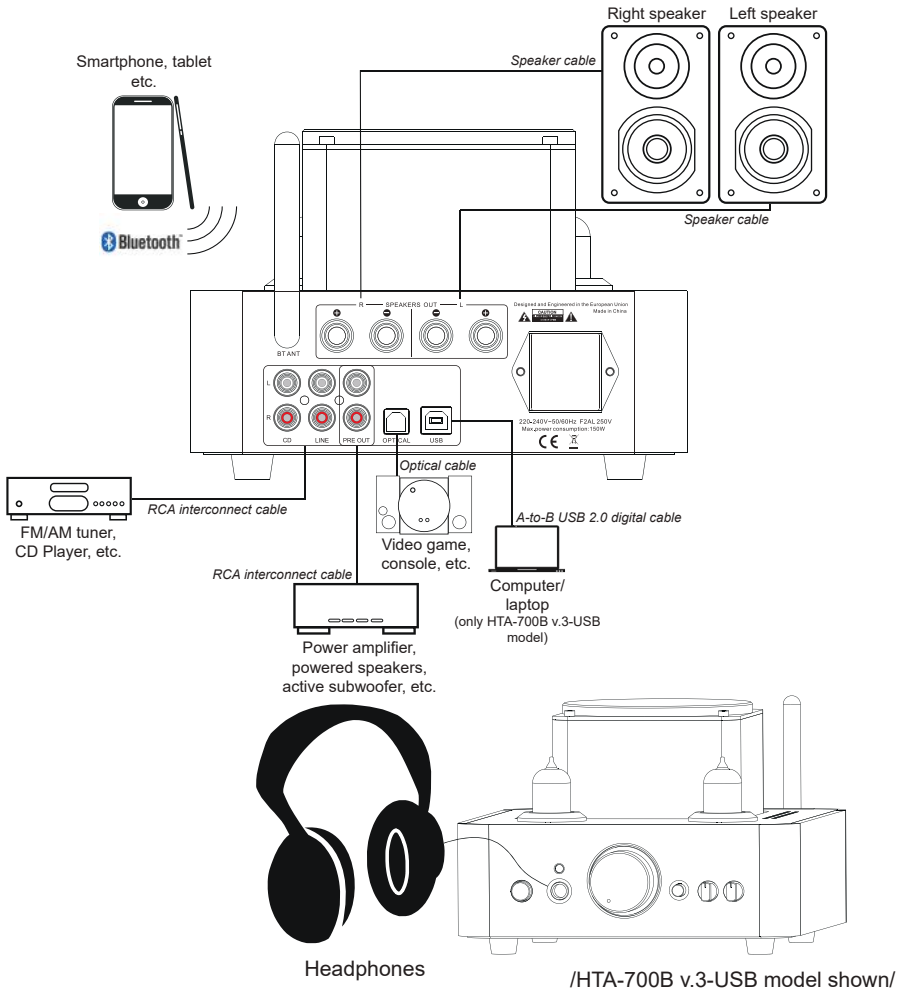

Hooking up the Amplifier

1. Make sure the amplifier is switched off (the Power Switch is in the top **■**OFF position and the Power Cable is removed).
2. Turn the Volume Regulator to MIN (max counter clockwise). Screw in the **Bluetooth®** antenna into the antenna socket.
Note! Make sure the antenna is securely and firmly installed - otherwise the "HTA-700B v.3" **Bluetooth®** device may not be found or connection may be unstable.
3. Using speaker cables (not supplied with this product) connect your speakers to SPEAKERS OUT connectors located on the rear of the amplifier (check "Hooking Up Speaker Cables" for more details).
4. HTA-700B v.3-USB model only: If you want to play music from a computer: using a A-to-B USB 2.0 digital cable (not supplied with this product) connect the computer to the USB Input port (check "USB Connection" for more details).
5. If you want to play music from audio sources equipped in an analog output (CD player, satellite or FM tuner, video console etc.): using RCA interconnect cables (not supplied with this product) connect them to the analog inputs (CD, LINE).
6. If you want to play a digital audio source equipped in an optical output (CD player, video console etc.): using a digital optical cable (not supplied with this product) connect it to the Digital Optical Input.
7. Preamplifier Output (PRE OUT): this amplifier is equipped with a preamplifier output. Using an RCA interconnect cable (not supplied with this product) you can connect to it external equipment (power amplifier, powered speakers, active subwoofer etc.). The PRE OUT level is variable controlled according to the Volume Regulator.
8. If you want to listen to music via headphones: connect the headphones to the Headphones output (check "Headphones connection" for more details).
9. If you want to stream music via **Bluetooth®** from compatible devices check "**Bluetooth®** Connection" for more details.
10. Your amplifier is ready for operation.

Note! Avoid to short-circuit of cables – it can damage this amplifier or speakers. This may void your warranty.

Note! Only speakers within range of impedance 4 - 8Ω can be connected. Connecting speakers outside this range can damage this amplifier and/or speakers. This may void your warranty.

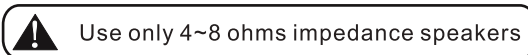

Operation

1. Plug the Power Cable to the amplifier and into the electrical outlet.
2. Turn on the amplifier – press the Power Switch (the Power Switch should be in the down **■** ON position). The status LED located on the Volume Regulator should turn red in a few seconds. If it does not, it means that the amplifier is working under an abnormal condition (a protection mode) – turn off the power, unplug the Power Cable and check whether some of the cables are not short circuited. After fixing the cables turn the amplifier on.
3. By pressing the Input Selector button on the front panel or pressing one of input selector button on the remote controller, select which audio source you want to play. Make sure the audio source is properly connected to the rear panel inputs. The selected source is indicated by one of LED indicators on the front panel.
4. Switch on your audio source and start playback.
5. Regulate volume on the amplifier to adjust level of sound.

Note! High volume levels can damage this amplifier and/or speakers. This may void your warranty.

Note! Check “Additional Information” for other useful operating instructions.

Headphones connection:

When headphones (not supplied with this product) are plugged into the headphone output (Headphones) the transmission of sound to the speakers and PRE OUT is switched off. The speakers and PRE OUT are again active after you disconnect the headphones.

The volume of the headphones is regulated by the Volume Regulator (front panel and remote controller).

All sound regulations (Bass / Treble) will affect the sound transmitted to the headphones.

Note! Listening at high volume can cause hearing damage.

Volume Regulator (front panel and remote controller):

Using the Volume Regulator on the front panel or down **▼** and up **▲** buttons on the remote controller, you can adjust the sound volume from minimum (the knob – max counterclockwise) to maximum (the knob – max clockwise).

Note! Distortion and sound quality worsening may occur when the knob is in the maximum position. It may damage the amplifier or speakers. This may void your warranty.

MUTE (remote controller):

During playback press this button to stop amplifier audio output (no sound will be audible in speakers, headphones nor through the PRE OUT).

Press the Mute or volume regulation buttons on the remote controller to recover the audio signal output back.

Operation

TREBLE regulator (front panel):

You can adjust treble output of the amplifier. The default: the knob is in the center position : the marker on the knob in the vertical position. Turn the knob counterclockwise (-) to decrease the amount of high frequencies. Turn the knob clockwise to increase the amount of high frequencies (+).

BASS regulator (front panel):

You can adjust bass output of the amplifier. The default: the knob is in the center position : the marker on the knob in the vertical position. Turn the knob counterclockwise (-) to decrease the amount of low frequencies. Turn the knob clockwise (+) to increase the amount of low frequencies (+).

USB Connection (only HTA-700B v.3-USB model)

Computers with Windows®

Note! Computer devices generate a significant amount of noise and interference which can get through USB ports to this amplifier.

If you can hear disturbing noise and interference in speakers or headphones when using the amplifier's USB-DAC then it may mean that your computer device is tend to the above mentioned problem.

In such a case we recommend to use a USB data and power noise filter (not supplied with this product) which should be plugged between the computer device and the A-to-B USB 2.0 digital cable which is connected to the amplifier.

1. Install the USB BRAVO-HD Audio Device driver (supplied by SAVITEC, USB Audio IC manufacturer).

Note! The driver may be not required for some Windows® operating system versions.

- The driver package as a compressed zip file is available for download on **www.TagHarmony.com** on a page of this product.
- After downloading extract the files from the zip file.
- Run the Setup file located in the unzipped folder and follow the installation instructions on the screen.
- When the installation finishes a shortcut icon of the BRAVO-HD will be created on the desktop and the restart wizard will appear. Make sure to restart the computer after the installation is completed.

2. The computer will recognize the amplifier as “HTA-700B v.3” and automatically apply it as the audio output device.

You can check the setting through the Control Panel → Hardware and Sound → Sound → Manage Audio Devices (Figure 1).

If the “HTA-700B v.3” is not selected then locate and highlight it and click “Set Default”.

To enjoy the best sound quality, we suggest to change a default format (bit and sample rate) of your audio device to the highest available – right-click on the HTA-700B v.3” device, choose Properties and then Advanced tab and change Default Format.

Note! If there is any problem with recognizing the amplifier by the computer disconnect and reconnect the USB cable.

Trademark notice:

Windows® is a registered trademark of Microsoft Corporation in the United States and/or other countries.

Operation

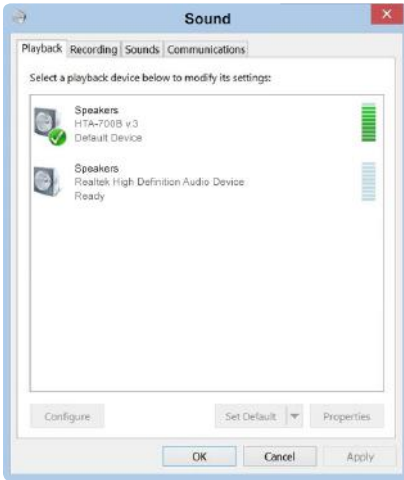

Figure 1

3. You can now listen to the playback from the computer and amplifier.

4. You can also control playback settings through the USB BRAVO-HD Audio Device Control Panel (Figure 2).

- Start the BRAVO-HD program from the desktop or program menu. The BRAVO-HD Control Panel will appear.
- If the amplifier is switched on and connected to the computer the panel will display:
 - The current default format (sample and bit rate) as selected in the Windows® system. Changing will affect a default format of your audio device in the Windows® system.
 - The current setting of playback via ASIO (preferred bit rate and buffer size).
Click to change.

Note!

- If the sound is unstable and noisy lower the sampling frequency and restart the playback.
- The bit rate setting should be the same as or higher than the playback file. Otherwise the bit rate or output is lower than the original.
- For some files if the bit rate is set too high such files may not be played.
- [USB BRAVO-HD Audio Device Control Panel] setting the smaller buffer size for a higher resolution music file may cause noises or interruption. Set the buffer size to bigger and restart the playback.
- You may also need to adjust the volume in your music player software.

Note! Operation and user interface may vary depending on your Windows® version.

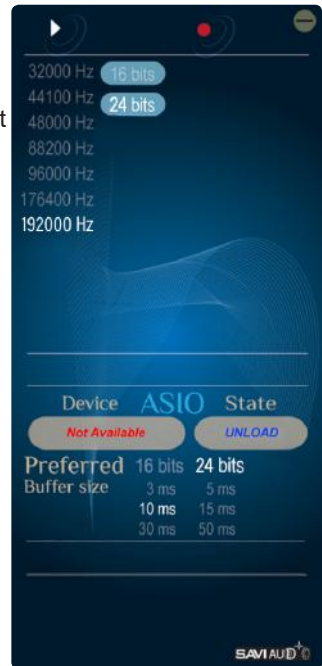

Figure 2

Operation

Bluetooth® Connection

- After the amplifier is switched on - the built-in **Bluetooth®** receiver is waiting to be paired with a **Bluetooth®** source.
- Select the BT input – the blue BT LED indicator will be flashing.
- Select **Bluetooth®** on your audio source (smartphone, laptop etc.) and start scanning for available **Bluetooth®** devices.
- After a short time “HTA-700B v.3” will appear on the screen of your audio source. Select “Pair” on your audio source to connect with the amplifier. After connection is successful the BT LED indicator will be illuminated continuously and it will remain illuminated as long as the current connection is active.
- HTA-700B v.3 will now be ready to play your music wirelessly within a range of approximately 7 meters. Start playback on your audio source.

Note! Please refer to your audio source user instruction for details on operating the **Bluetooth®**. Operation and names of specific functions can vary on different devices.

Important Notes - Bluetooth® Connection

- As long as the amplifier is not switched off for longer than 10 seconds – the current **Bluetooth®** connection is active (even if you change the input). After that time the connection is lost and you will have to repeat the pairing procedure.
- When you move away from the working range of the HTA-700B v.3 **Bluetooth®** receiver for longer than 60 seconds, the current **Bluetooth®** connection will be lost and you will have to repeat pairing procedure. Within 60 seconds the connection can be automatically reconnected.
- When you want to use another **Bluetooth®** audio source than currently active, you have to disconnect the active connection and start the **Bluetooth®** connection procedure.
- Make sure the antenna is securely and firmly installed as well that it is not obscured- otherwise the “HTA-700B v.3” **Bluetooth®** device may not be found or connection may be unstable.

Additional information

Break-In

Your TAGA Harmony amplifier sounds great immediately after it is taken out of the carton but as all hybrid amplifiers, this amplifier requires a “break-in” period to reach its full sonic capabilities.

During the “break-in” period it is recommended to operate the amplifier at moderate volume levels.

The first level of the “break-in” is reached after approximately 10 hours of play.

The optimal level of the “break-in” is reached after approximately 40 to 60 hours of play.

It is recommended to avoid one-time short periods of operation unless the amplifier reaches the first “break-in” level.

When the amplifier is turned on, it should operate for around 4-6 hours.

Turn off procedure

Make sure to turn off the amplifier first when powering down your system.

Note! If the amplifier was turned off even for a short period of time, you should wait at least 2 minutes before turning it back on. Do not turn it ON then OFF and then ON again in quick succession.

Follow this procedure each time you turn your amplifier OFF / ON. This precaution will minimize the stress (high voltages) on internal components.

Vacuum Tube Replacement

The lifetime of vacuum tubes may vary and depends on their operation time and ambient temperature, playback volume levels and the number of on and off cycles.

Note! The warranty time for vacuum tubes is shorter than for other components of this device - for more details check your warranty terms or contact a local dealer.

Replacement vacuum tubes are not supplied with this product.

To replace the vacuum tube:

1. Turn off the amplifier.
2. Unplug the Power Cable from the electrical outlet.
3. Wait for approximately 30 minutes to cool down vacuum tubes. Make sure that the vacuum tubes are cool.
4. The vacuum tubes are installed in sockets. Remove the vacuum tube you want to replace by gently pulling it out of the tube socket.
5. Make sure to replace the vacuum tube with the same type or with another type which is a direct equivalent of the factory installed one.
Gently but firmly place the new vacuum tube in the socket.
6. Before turning on the amplifier wait until the newly installed tubes reach the temperature of the room.

Specifications

Design	Hybrid amplifier Class A/B
Vacuum tubes	2 x 12AU7
Power output / impedance	2 x 26W 8Ω 2 x 45W 4Ω
DA converter	24bit / 192 kHz
Wireless connectivity	Bluetooth® v4.0
Digital inputs	Optical, USB* (for computer)
Analog inputs	CD, Line
Analog outputs	RCA Pre-Out

Headphone output	Impedance: 32 - 300Ω Output power: 300mW, 300Ω
Frequency response	20Hz - 20kHz (±2dB)
Total Harmonic Distortions	≤1% (1kHz/ 1W)
Signal / Noise ratio	75dB
AC power / power consumption	220-240V 50/60Hz, 150W
Dimensions (H x W x D)	14 x 20 x 27 cm
Weight	5.2 kg / pc.

Bluetooth® is a registered trademark of Bluetooth SIG, Inc.
We reserve the right to change the technical data and the design of the product without notice as a result of further development.

*Applies to the HTA-700B v.3-USB model

We strongly advise to contact a professional installer or dealer in order to install TAGA Harmony products.

We recommend using high quality TAGA Harmony cables and other installation accessories.

Kit Content:

Amplifier	1EA
Bluetooth® Antenna	1EA
Remote Controller	1EA
Power Cable	1EA
Instruction Manual	1EA



Your product is marked with the symbol as showed on the left.
For EU (European Union) member users:
This product has been tested and found in compliance with requirements of the European Community 2014/30/EU (EMC) & 2014/35/EU (LVD) & 2014/53/EU (RED) directives.



IMPORTANT!
Your product is marked with the symbol as showed on the left.
For EU (European Union) member users:
According to the WEEE (Waste electrical and electronic equipment) Directive, do not dispose of this product as household waste or commercial waste. Waste electrical and electronic equipment should be appropriately collected and recycled as required by practices established for your country.
For information on recycling of this product, please contact your local authorities, your household waste disposal service or the shop where you purchased the product.

TAGA EUROPE
POLPAK POLAND Sp. z o.o.
AL.JEROZOLIMSKIE 333A
05-816 REGULY k/WARSZAWY, POLAND
Email: Sales@TagaHarmony.com

www.TagaHarmony.com

Notes

Notes

Notes
